

# MATHEY DEARMAN®

## PIPE FLAME CUTTING AND BEVELLING





The industry standard for over 90 years, the Mathey Dearman saddle machine is versatile, simple to use, and perfect for almost any pipe cutting and beveling application. Lightweight and durable, the Mathey Dearman machine is designed for accurate, quality cuts on 1½" - 48" (48.3 mm - 1,219 mm) pipes.

- Versatile** - Every model works on a range of pipe sizes
- Adaptable** - Works with all standard torches, including plasma
- Portable** - Light and compact, perfect for shop or field applications
- Easy Set-Up** - Mount and begin cutting in as little as 5 minutes
- Proven** - Depended on by professionals for over 70 years
- Fast** - Pipe is ready to weld up to five times quicker than hand cutting and grinding

**Mathey Dearman has been the leader in pipe cutting since its invention of the saddle machine in 1934.**

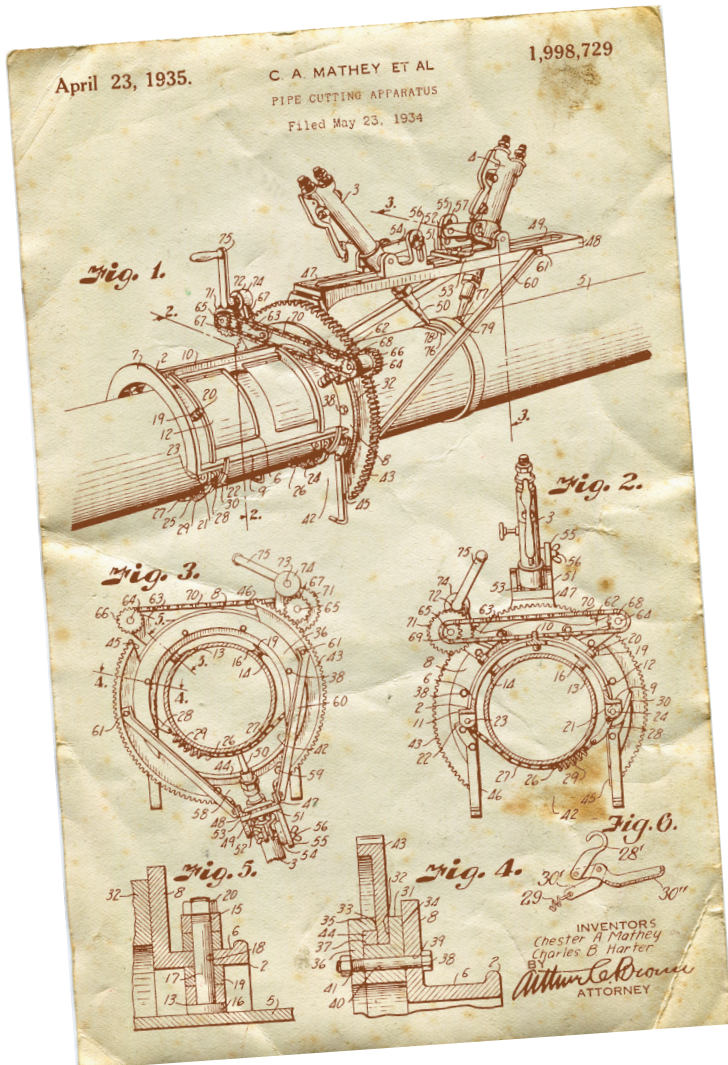

**Manual saddle machine includes:**

- Saddle machine
- Torch arm
- Torch carrier assembly
- Boomer assembly (fastens the machine to the pipe)
- Spacer bolt set
- Parts and operating manual

**Note:** Machine torches sold separately.





Want the easiest way to get a perfect cut every time?

Motorized saddle machines from Mathey Dearman are precise and fast, delivering smooth cuts requiring little or even no grinding.

Both experienced and inexperienced welders can benefit from the increased productivity (up to 5 times quicker!) and cut quality of motorized saddle machines compared to traditional hand-cutting or manual machines.

Motorized PLASMASPEED saddle machines can use 110/230 VAC for pipe sizes 1½" - 48" (48.3 mm - 1,219 mm) and can operate at increased cutting speeds to use powerful plasma torches.

It's what Mathey Dearman calls PLASMASPEED!

**Motorized saddle machine includes:**

- 110/230 VAC motorized saddle machine
- Torch arm
- Torch carrier assembly
- Boomer assembly (fastens the machine to the pipe)
- Spacer bolt set
- Parts and operating manual
- Mounting bracket
- Right-angle precision stepper motor
- Motor control box
- Plasma communication cable

**Note:** Machine torches sold separately - machine shown with optional step spacers and pro model torch.



**Conventional cutting vs saddle cutting time**

**Hand cutting**

**Time: 30 minutes**

- 8" schedule 40 pipe being cut by hand.  
Time includes measuring, cutting and grinding
- Longer than necessary layout time
- Excessive amount of time to cut the pipe
- Inaccurate/uneven cut requiring grinding
- Extended fit-up time
- Uneven weld gap

**Mathey Dearman cutting**

**Time: 6 minutes**

- 8" schedule 40 Pipe being cut with a 1SA manual saddle machine
- Perfect cut
- No grinding
- Perfect fit-up

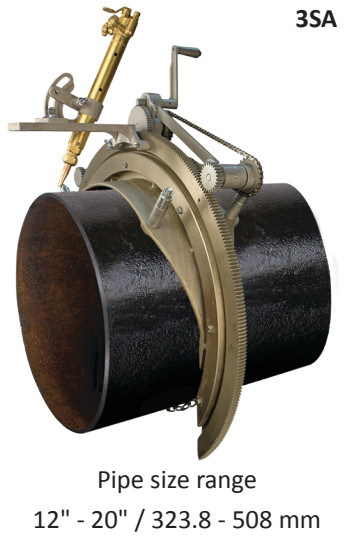
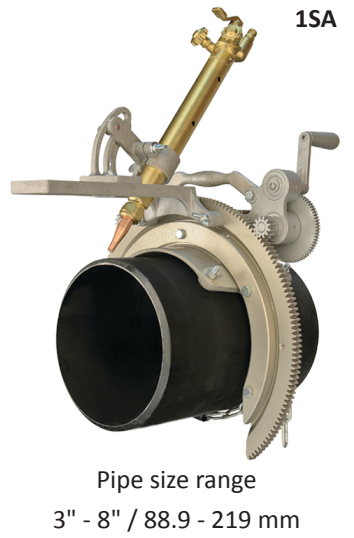

## Manual saddle machines

MACHINE MODEL	MSA	1SA	2SA
Manual with spacer bolts	03.0100.000	03.0101.000	03.0102.000
Manual with step spacers	n/a	03.01S1.000	03.01S2.000

## Motorized saddle machines / PLASMASPEED

MACHINE MODEL	MSA	1SA	2SA
Motorized with spacer bolts 115/230 VAC	03.0100.S01	03.0101.S01	03.0102.S01
Motorized with step spacers 115/230 VAC	n/a	03.01S1.S01	03.01S2.S01

## PLASMASPEED retrofit kits

MACHINE MODEL	MSA	1SA	2SA
PLASMASPEED retrofit kits 115/230 VAC	03.0100.SA1	03.0101.SA1	03.0101.SA1

## General specifications

MACHINE MODEL	MSA	1SA	2SA
Pipe size in (mm)	2" - 4" (60.3 - 114.3 mm)	3" - 8" (88.9 - 219 mm)	6" - 12" (168.2 - 323.8 mm)
Net weight lbs. / kg	10 lbs. / 5.00 kg	16 lbs. / 7.00 kg	26 lbs. / 12.00 kg
Estimated shipping weight lbs. / kg	12 lbs. / 5.40 kg	24 lbs. / 11.00 kg	34 lbs. / 15.50 kg
Shipping dimensions in (mm)	12" x 12" x 10" (305 x 305 x 254 mm)	18" x 18" x 11½" (457 x 457 x 492 mm)	23" x 23" x 12½" (584 x 584 x 318 mm)
Maximum speed (motorized) ipm* / mpm**	141 / 3581	71 / 1803	89 / 2261
Minimum speed (motorized) ipm* / mpm**	4 / 102	4 / 102	6 / 152
Includes spacer bolts to cut pipe sizes	2", 3", 4" (60.3, 88.9, 114.3 mm)	3", 4", 6", 8" (88.9, 114.3, 168.2, 219 mm)	6", 8", 10", 12" (168.2, 219, 273, 323.8 mm)

\* inches per minute | \*\* millimeters per minute





4SA

Pipe size range

20" - 26" / 508 - 660 mm

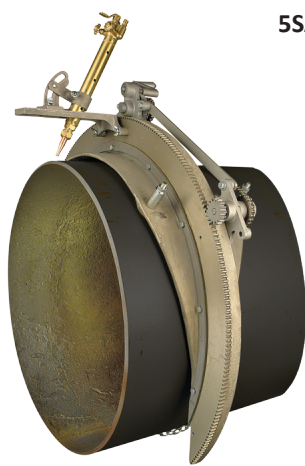

5SA

Pipe size range

24" - 30" / 610 - 762 mm

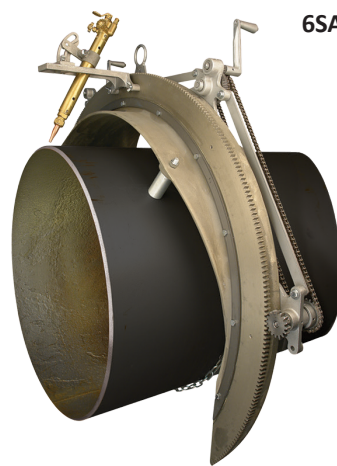

6SA

Pipe size range

28" - 36" / 711 - 914 mm



8SA

Pipe size range

36" - 48" / 914 - 1,219 mm

3SA	4SA	5SA	6SA	8SA
03.0103.000	03.0104.000	03.0105.000	03.0106.000	03.0108.000
03.0153.000	n/a	n/a	n/a	n/a

3SA	4SA	5SA	6SA	8SA
03.0103.S01	03.0104.S01	03.0105.S01	03.0106.S01	03.0108.S01
03.0153.S01	n/a	n/a	n/a	n/a

3SA	4SA	5SA	6SA	8SA
03.0103.SA1	03.0103.SA1	03.0105.SA1	03.0105.SA1	03.0105.SA1

3SA	4SA	5SA	6SA	8SA
12" - 20" (323.8 - 508 mm)	20" - 26" (508 - 660 mm)	24" - 30" (610 - 762 mm)	28" - 36" (711 - 914 mm)	36" - 48" (914 - 1,219 mm)
50 lbs. / 22.00 kg	75 lbs. / 34.00 kg	110 lbs. / 50.00 kg	180 lbs. / 82.00 kg	287 lbs. / 130.00 kg
73 lbs. / 33.00 kg	150 lbs. / 68.00 kg	185 lbs. / 84.00 kg	295 lbs. / 134.00 kg	537 lbs. / 244.00 kg
34" x 32" x 12" (864 x 813 x 305 mm)	40½" x 41" x 19" (1,029 x 1,041 x 423 mm)	40½" x 41" x 19" (1,029 x 1,041 x 423 mm)	57" x 43" x 18" (1,488 x 1,002 x 483 mm)	69" x 60" x 21" (1,753 x 1,524 x 533 mm)
47 / 1194	53 / 1346	34 / 864	35 / 889	36 / 914
7 / 178	7 / 178	8 / 203	5 / 127	5 / 127
12", 14", 16", 18", 20" (323.8, 356, 406, 457, 508 mm)	20", 22", 24", 26" (508, 559, 610, 660 mm)	24", 26", 28", 30" (610, 660, 711, 762 mm)	28", 30", 36" (711, 762, 914 mm)	36", 38", 40", 42", 48" (914, 964, 1,016, 1,067, 1,219 mm)

**Contour cutting attachment** - When cutting a 90° saddle on 8" pipe, the combination of the saddle machine and contour cutting attachment reduces cutting and grinding time by up to 80%.



MODEL	PIPE SIZE		PART NO.	PACKAGED WEIGHT		PACKAGED DIMENSIONS	
MSA	1.5" - 4"	48.3 - 114.3 mm	03.0116.MSA	7 lbs.	3.20 kg	23" x 10" x 9"	584 x 254 x 229 mm
1 - 2 SA	3" - 12"	88.9 - 323.8 mm	03.0116.1SA	7 lbs.	3.20 kg	36" x 12" x 12"	914 x 305 x 305 mm
3SA	12" - 20"	323.8 - 508 mm	03.0116.3SA	9 lbs.	4.10 kg	36" x 12" x 12"	914 x 305 x 305 mm
4SA	20" - 26"	508 - 660 mm	03.0116.4SA	9 lbs.	4.10 kg	36" x 12" x 12"	914 x 305 x 305 mm
5SA	24" - 30"	610 - 762 mm	03.0116.5SA	11 lbs.	5.00 kg	48" x 12" x 12"	1,219 x 305 x 305 mm
6SA	28" - 36"	711 - 914 mm	03.0116.6SA	13 lbs.	5.90 kg	48" x 12" x 12"	1,219 x 305 x 305 mm
8SA	36" - 48"	914 - 1,219 mm	03.0116.8SA	16 lbs.	7.20 kg	48" x 12" x 12"	1,219 x 305 x 305 mm

**Contour cutting shape templates** - Produce perfect miter and saddle cuts with the easy to use Mathey Dearman contour cutting attachment. Simply choose the template for the desired type of cut and the torch will follow the template around the pipe. Contour cutting attachments and templates are available for 1½" - 48" (48.3 mm - 1,219 mm) pipe.



**NOTE:** Template form is required prior to order - template cannot be returned

MODEL	SPACERS FOR PIPE SIZES		PART NO	PACKAGED WEIGHT		PACKAGED DIMENSIONS	
MSA	1.5" - 4"	48.3 - 114.3 mm	03.0115.M . .	3.5 - 5 lbs.	1.60 - 2.30 kg	12" x 12" x 9"	305 x 305 x 229 mm
1SA	3" - 8"	88.9 - 219 mm	03.0115.1 . .	4.5 - 6 lbs.	2.00 - 2.70 kg	18" x 18" x 11"	457 x 457 x 279 mm
2SA	8" - 12"	219 - 323.8 mm	03.0115.2 . .	6 - 8 lbs.	2.70 - 3.60 kg	23" x 23" x 13"	584 x 584 x 330 mm
3SA	12" - 20"	323.8 - 508 mm	03.0115.3 . .	11 - 15 lbs.	5.00 - 7.00 kg	36" x 12" x 12"	914 x 305 x 305 mm
4SA	20" - 26"	508 - 660 mm	03.0115.4 . .	18 - 27 lbs.	8.00 - 12.00 kg	36" x 36" x TBD	914 x 914 x TBD mm
5SA	24" - 30"	610 - 762 mm	03.0115.5 . .	22 - 31 lbs.	10.00 - 14.00 kg	42" x 48" x TBD	1,067 x 1,219 x TBD mm
6SA	28" - 36"	711 - 914 mm	03.0115.6 . .	27 - 35 lbs.	12.00 - 16.00 kg	48" x 48" x TBD	1,219 x 1,219 x TBD mm
8SA	36" - 48"	914 - 1,219 mm	03.0115.8 . .	31 - 40 lbs.	14.00 - 18.00 kg	60" x 60" x TBD	1,524 x 1,524 x TBD mm

**Double torch arm** - Reduce set up and cutting time by up to 50% with the double torch arm accessory. By eliminating the need to rotate one torch to obtain a forward or back bevel on the pipe end, the double torch arm dramatically reduces cutting and beveling time.



MODEL	PIPE SIZE		PART NO	PACKAGED WEIGHT		PACKAGED DIMENSIONS	
1SA	3" - 8"	88.9 - 219 mm	03.0101.030	5 lbs.	2.30 kg	20" x 6" x 6"	508 x 152 x 152 mm
2SA	8" - 12"	219 - 323.8 mm	03.0102.015	5 lbs.	2.30 kg	20" x 6" x 6"	508 x 152 x 152 mm
3SA	12" - 20"	323.8 - 508 mm	03.0103.030	5 lbs.	2.30 kg	23" x 10" x 9"	584 x 254 x 229 mm
4SA	20" - 26"	508 - 660 mm	03.0104.021	5 lbs.	2.30 kg	23" x 10" x 9"	584 x 254 x 229 mm
5SA	24" - 30"	610 - 762 mm	03.0105.025	5 lbs.	2.30 kg	23" x 10" x 9"	584 x 254 x 229 mm
6SA	28" - 36"	711 - 914 mm	03.0106.018	5.5 lbs.	2.50 kg	23" x 10" x 9"	584 x 254 x 229 mm
8SA	36" - 48"	914 - 1,219 mm	03.0108.014	5.5 lbs.	2.50 kg	23" x 10" x 9"	584 x 254 x 229 mm

**Pro model torch arm** - Choose the pro model torch arm with the innovative out-of-round roller attachment to create perfect cuts and bevels on oversize, undersize or out-of-round pipe.

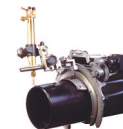

DESCRIPTION	PART NO	PACKAGED WEIGHT		PACKAGED DIMENSIONS	
Pro model with out of round	03.0209.000	9.50 lbs.	4.30 kg	16" x 8" x 8"	406 x 203 x 203 mm
Pro model basic assembly	03.0209.001	7 lbs.	3.20 kg	16" x 8" x 8"	406 x 203 x 203 mm
Tracer point	03.0209.012	1.60 lbs.	0.70 kg	12" x 6" x 6"	305 x 152 x 152 mm

Torch holders that can accommodate up to 2" barrel diameter torches are available



## Out-of-round roller attachment

The out-of-round roller attachment kit, that can be fitted on the pro model torch arm, compensates for oversize and undersize pipe, handling out-of-round conditions up to ¼" (6 mm).

This separate attachment comes with all required parts and assembly instructions.

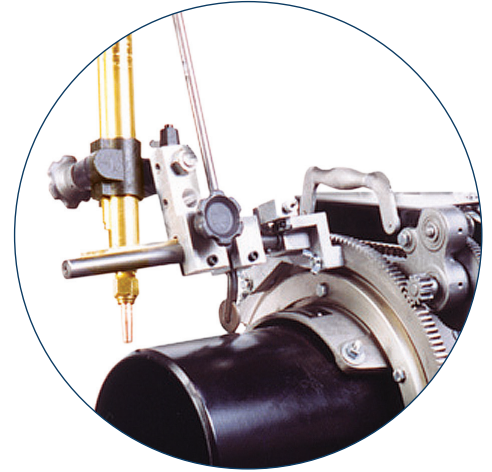

Pro model with out-of-round roller attachment kit installed

DESCRIPTION	PART NO	PACKAGED WEIGHT		PACKAGED DIMENSIONS	
Out of round kit	03.0209.003	2.50 lbs.	1.10 kg	12" x 6" x 6"	305 x 152 x 152 mm

## Cam-adjustable torch carrier

The cam-adjustable torch carrier makes it simple to make perfect, no-notch cuts, every time. Just start the cut away from the desired cut line, use the knurled cam adjustment knob to move the torch into the cut line then start cutting. In addition, the torch holder's large wing screw makes tightening the torch in the torch holder easy, even when wearing gloves. The innovative design even allows forward or back-beveling without the need to reverse the torch holder in the torch arm.

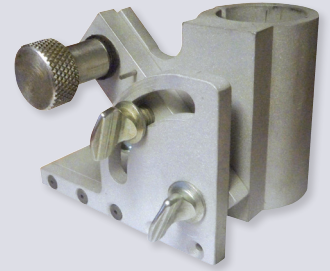

**ITEM NO. 03.0100.052**

## Saddle machine storage box

Store and help protect the saddle machine, torch, torch arm, torch carrier, spacer bolts and parts and operating manual in this specially-designed storage box.

MSA, 1SA, and 2SA storage boxes are made of 16 gauge, powder-coated steel, with attached lifting handles.

Storage boxes for saddle machines larger than the 3SA are made of plywood with reinforced corners and edges.



MODEL	PART NO	DIMENSIONS		MANUAL OR MOTORIZED	BOX TYPE	PACKAGED WEIGHT	
MSA	03.0100.BOX	17" x 17" x 17"	432 x 432 x 432 mm	Manual only	Metal	23 lbs.	11.00 kg
1SA	03.0101.BOX	20" x 18" x 17"	205 x 457 x 432 mm	Manual only	Metal	33 lbs.	15.00 kg
2SA	03.0102.BOX	25" x 22" x 18"	635 x 559 x 457 mm	Manual only	Metal	41 lbs.	19.00 kg
3SA	03.0103.BOX	34" x 34" x 14"	864 x 864 x 356 mm	Manual or motorized	Wood	60 lbs.	27.00 kg
4SA	03.0104.BOX	40" x 38" x 14"	1,016 x 965 x 356 mm	Manual or motorized	Wood	75 lbs.	34.00 kg
5SA	03.0105.BOX	42" x 40" x 14"	1,067 x 1,016 x 356 mm	Manual or motorized	Wood	75 lbs.	34.00 kg
6SA	03.0106.BOX	56" x 48" x 16"	1,422 x 1,219 x 406 mm	Manual only	Wood	175 lbs.	79.00 kg
8SA	03.0108.BOX	70" x 56" x 19"	1,778 x 1,422 x 483 mm	Manual only	Wood	250 lbs.	102.00 kg

\* No spacers required for 4" pipe set up

## Self-storing step-down spacer

Combining multiple spacer bolt sizes into one easy-to-use part, the step-down spacers are machined to the same tolerances as spacer bolts. Each step spacer covers a range of four (4) pipe sizes; eliminating the need to store 16 spacer bolts. No more searching for lost or misplaced spacer bolts with high quality aluminum alloy or stainless steel self-storing step-down spacers.

## Step spacer kit

DESCRIPTION	PART NO	FOR PIPE SIZES		PACKAGED WEIGHT	
1SA Step Spacers	03.0110.1SAKIT	3", 4", 6", 8"	88.9 mm, 114.3 mm, 168.2 mm, 219 mm	1.60 lbs.	0.70 kg
2SA Step Spacers	03.0110.2SAKIT	6", 8", 10", 12"	168.2 mm, 219 mm, 273 mm, 323.8 mm	1.60 lbs.	0.70 kg
3SA Step Spacers	03.0110.3SAKIT	12", 14", 16", 18", 20"	323.8 mm, 356 mm, 406 mm, 457 mm, 508 mm	1.60 lbs.	0.70 kg

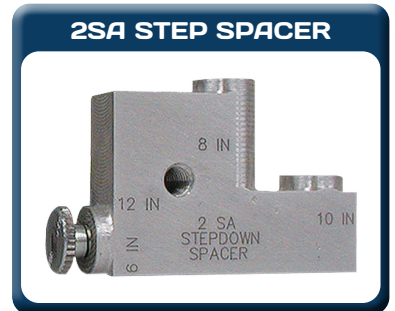

## Step spacers (individual)

DESCRIPTION	PART NO	FOR PIPE SIZES		PACKAGED WEIGHT	
1SA Step Spacer	03.0110.1SA	3", 4", 6", 8"	88.9 mm, 114.3 mm, 168.2 mm, 219 mm	0.40 lbs.	0.20 kg
2SA Step Spacer	03.0110.2SA	6", 8", 10", 12"	168.2 mm, 219 mm, 273 mm, 323.8 mm	0.40 lbs.	0.20 kg
3SA Step Spacer	03.0110.3SA	12", 14", 16", 18", 20"	323.8 mm, 356 mm, 406 mm, 457 mm, 508 mm	0.40 lbs.	0.20 kg



## Saddle machine spacer bolts

Spacer Bolt Kits include the spacer bolts in one handy container available for any Mathey Dearman saddle machine model. An actual-size diagram is located on the lid, making finding the correct Spacer Bolts quick and easy. All spacer bolts are precision-machined for maximum cutting accuracy and labeled with the Mathey Dearman logo and item number for quick identification.

*Actual size is shown on box lid for quick spacer bolt identification.*

*Spacer bolts can be replaced individually or in sets.*

## Step spacers (individual)

DESCRIPTION	PART NO	FOR PIPE SIZES		PACKAGED WEIGHT	
MSA	03.0MSA.KIT	2", 3"	60.3 mm, 88.9 mm	1 lbs.	0.50 kg
1SA	03.01SA.KIT	3", 4", 6", 8"	88.9 mm, 114.3 mm, 168.2 mm, 219 mm	4 lbs.	1.80 kg
2SA	03.02SA.KIT	6", 8", 10", 12"	168.2 mm, 219 mm, 273 mm, 323.8 mm	5 lbs.	2.30 kg
3SA	03.03SA.KIT	12", 14", 16", 18", 20"	323.8 mm, 356 mm, 406 mm, 457 mm, 508 mm	9 lbs.	4.10 kg
4SA	03.04SA.KIT	20", 22", 24", 26"	508 mm, 559 mm, 610 mm, 660 mm	10 lbs.	4.50 kg
5SA	03.05SA.KIT	24", 26", 28", 30"	610 mm, 660 mm, 711 mm, 762 mm	10 lbs.	4.50 kg
6SA	03.06SA.KIT	28", 30", 36"	711 mm, 762 mm, 914 mm	20 lbs.	9.00 kg
8SA	03.08SA.KIT	36", 38", 40", 42", 48"	916 mm, 964 mm, 1,016 mm, 1,069 mm, 1,219 mm	20 lbs.	9.00 kg

\* No spacers required for 4" pipe set up





Mathey Dearman's E-Z Pipecut portable oxy-fuel cutting and bevelling chain driven machines are the economical solution for cutting and bevelling pipe with wall thickness 5 mm up to 50 mm.

The Mathey Dearman E-Z Pipecut Manual is small and compact, strong and reliable, used by contractors, welders and pipe fitters, equally on-site or in the workshop.

The E-Z Pipecut Manual portable is a straight forward hand operated compact chain - driven pipe cutting machine that provides a smooth, accurate cutting action by incorporating a low gear ratio and worm wheel drive.

The machine also features a quick-release clutch, that allows the operator to disengage the chain from the drive cog for rapid set up and positioning.

The bevelling head angle (up to 45°) can be set quickly and accurately by scale on a rack and pinion.

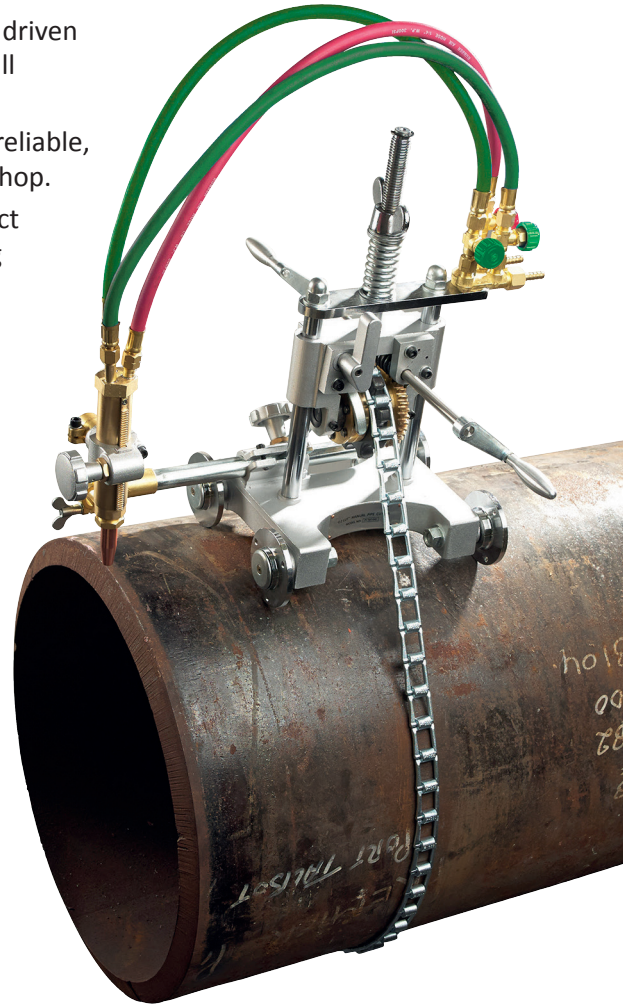
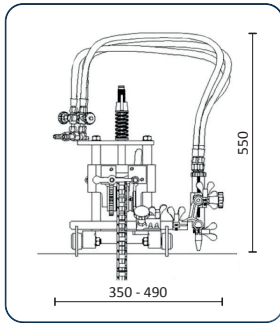
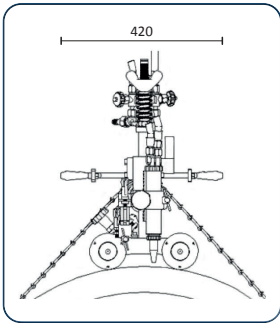

\* Outside the USA  
the green hoses  
will be blue



### Guide band

For guaranteed square cuts and bevels on pipe diameters larger than 600 mm, using the optional guide band system to suit the relevant pipe size(s) is recommended.

### E-Z Pipecut Manual includes:

- Cutting machine E-Z Pipecut manual
- Standard chain for cutting pipe diameter of 4½" - 24" / 114 - 600 mm
- Operation instructions

### Technical specification

Part No	EZPCM
Power supply	Manual driven unit
Pipe diameter	Up to 600 mm (in standard configuration)
Wall thickness	5 - 50 mm
Torch	Universal nozzle-mix torch suitable for all nozzle-mix cutting nozzle (nozzles not included)
Cut/bevel angle	Variable up to 45°
Vertical torch +/-	50 mm
Lateral torch +/-	100 mm
Track width	230 mm
Weight	8.50 kg / 18.70 lbs.
Dimensions	350 (l) x 420 (w) x 550 (h) mm

**Chain calculation:** Pipe diameter (inch) x 3.142 + 8 = (total inch) x 2.54 = (total cm)  
 E.G. 36" x 3.142 = 113.112 + 8 = (121.11 total inch) x 2.54 = (307.62 total cm)



The Mathey Dearman E-Z Pipecut Auto is the powered version of the E-Z Pipecut Manual. Once the speed is set correctly to the wall thickness of the pipe the machine can be driven around the pipe with a speed adjustable remote control.

The E-Z Pipecut Auto will cut and bevel the pipe without the need for intervention from the operator.

The E-Z Pipecut Auto portable oxy-fuel cutting machine can also be used for cutting exotic materials such as stainless steel, by converting from oxy-fuel to a plasma system (plasma torch holder available on request).

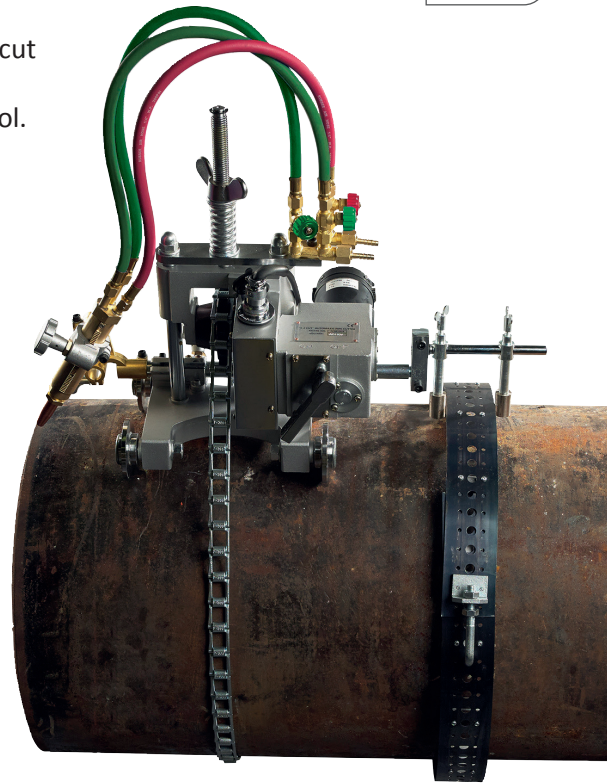
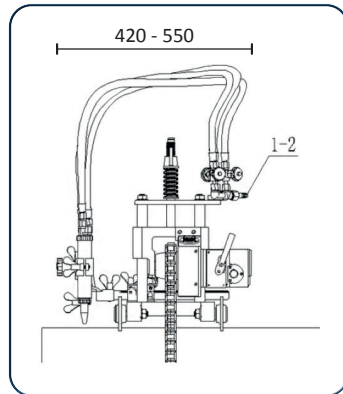
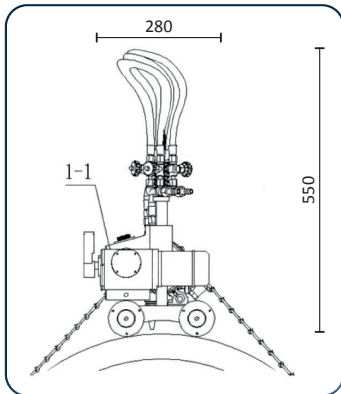

### Guide band

For guaranteed square cuts and bevels on pipe diameters larger than 600 mm, using the optional guide band system to suit the relevant pipe size(s) is recommended.

### Remote control

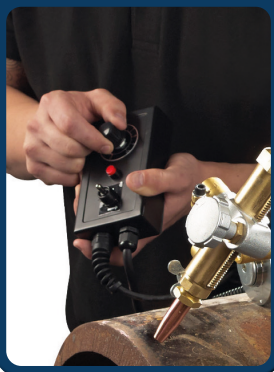

\* Outside the USA the green hoses will be blue

### E-Z Pipecut Auto includes:

- Pipe cutting machine E-Z Pipecut Auto
- Standard chain for cutting pipe diameter of 114 - 600 mm
- Connecting lead (5 m)
- Remote control
- Transformer 110v - 220v
- Operation instructions

### Technical specification

Part No	EZPCA1: 110v / EZPCA2: 220v
Power supply	230v / 110v / 50 - 60Hz
Pipe diameter	Up to 600 mm (in standard configuration)
Wall thickness	5 - 50 mm
Torch	Universal nozzle-mix torch suitable for all nozzle-mix cutting nozzle (nozzles not included)
Cut/bevel angle	Variable up to 45°
Vertical torch +/-	50 mm
Lateral torch +/-	100 mm
Track width	230 mm
Cutting speed	50 - 1,150 mm/min
Weight	16.00 kg / 36 lbs.
Dimensions	420 (l) x 280 (w) x 550 (h) mm

**Chain calculation:** Pipe diameter (inch) x 3.142 + 8 = (total inch) x 2.54 = (total cm)  
 E.G. 36" x 3.142 = 113.112 + 8 = (121.11 total inch) x 2.54 = (307.62 total cm)





The Mathey Dearman E-Z Pipecut Magnetic is the economical solution for cutting and bevelling pipe from 350 mm upwards. The machine is small and compact, strong and reliable, used by contractors, welders and pipe fitters, equally on site as in the workshop.

Two sets of magnetic, electrically driven roller wheels are housed inside the body of the machine. These rollers (offering a magnetic absorbability force of over 50 kg) ensure the machine stays in contact with the pipe as it travels around the circumference, cutting and bevelling as it goes.



### Guide band

For guaranteed square cuts and bevels on pipe diameters larger than 600 mm, using the optional guide band system to suit the relevant pipe size(s) is recommended.

**\* Outside the USA the green hoses will be blue**

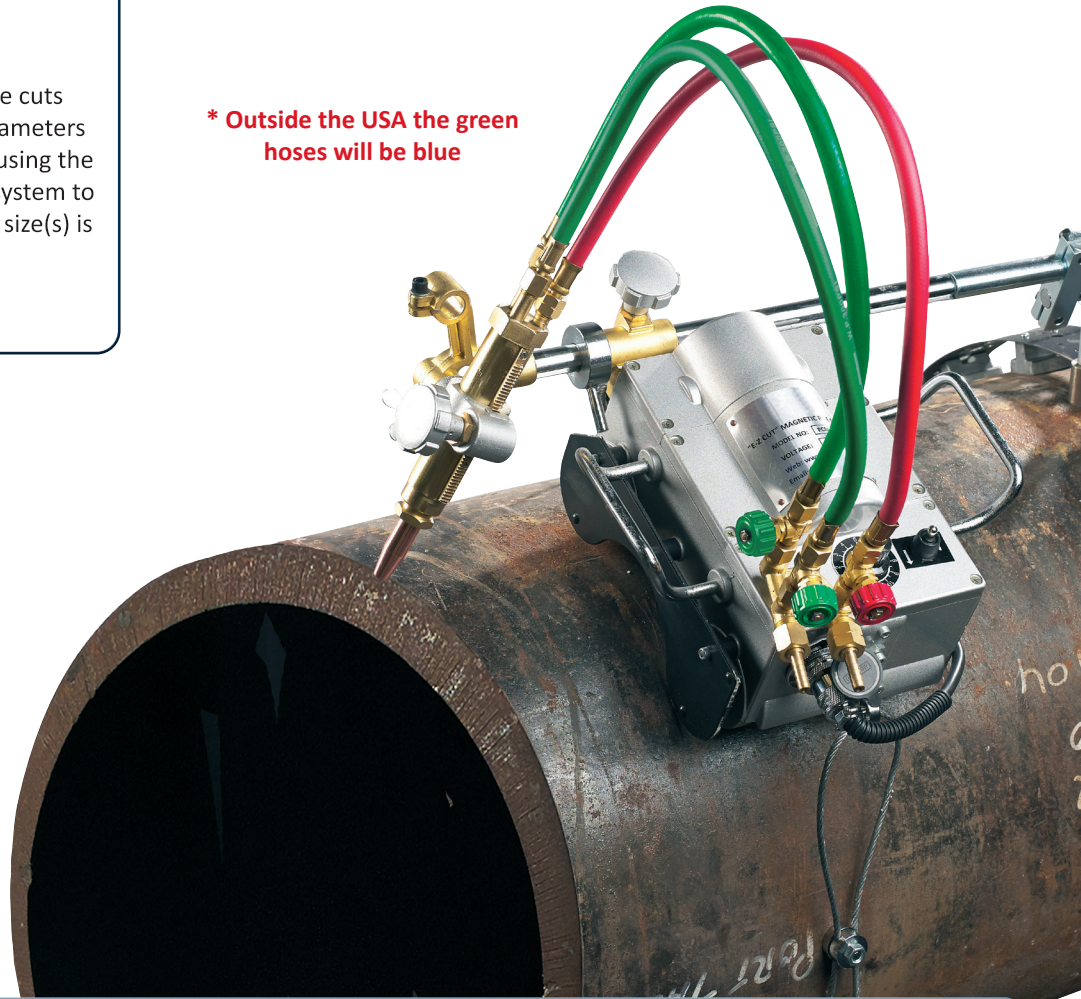

### E-Z Pipecut Magnetic includes:

- Pipe cutting machine E-Z Pipecut Magnetic
- Universal nozzle-mix torch suitable for all nozzle-mix cutting nozzle
- Gas hoses
- Power cable
- Operation instructions

### Technical specification

Part No	EZPCMA1: 110v / EZPCMA2: 220v
Power supply	110v / 220v
Pipe diameter	350 mm upwards
Wall thickness	5 - 50 mm
Torch	Universal nozzle-mix torch suitable for all nozzle-mix cutting nozzle (nozzles not included)
Cut/bevel angle	Variable up to 45°
Vertical torch +/-	50 mm
Lateral torch +/-	100 mm
Track width	50 - 780 mm/min
Weight	20.00 kg / 18.70 lbs
Dimensions	350 (l) x 310 (w) x 280 (h) mm

**Chain calculation:** Pipe diameter (inch) x 3.142 + 8 = (total inch) x 2.54 = (total cm)  
 E.G. 36" x 3.142 = 113.112 + 8 = (121.11 total inch) x 2.54 = (307.62 total cm)



# BAND CRAWLER CUTTING AND BEVELING MACHINE



The ideal solution for cutting and beveling in close quarters, the Band Crawler requires as little as 6" (168.2 mm) of clearance around the pipe. Install the stainless steel band anywhere on the pipe and it conforms to the pipe shape, producing a consistent precise bevel, even on severely out-of-round pipe.

The lightweight Band Crawler can be quickly set up and operated by one person on pipe as large as 60" (1,524 mm). Bands 48" (1,219 mm) and larger feature a standard stiffening rib which simplifies one-person set-up.

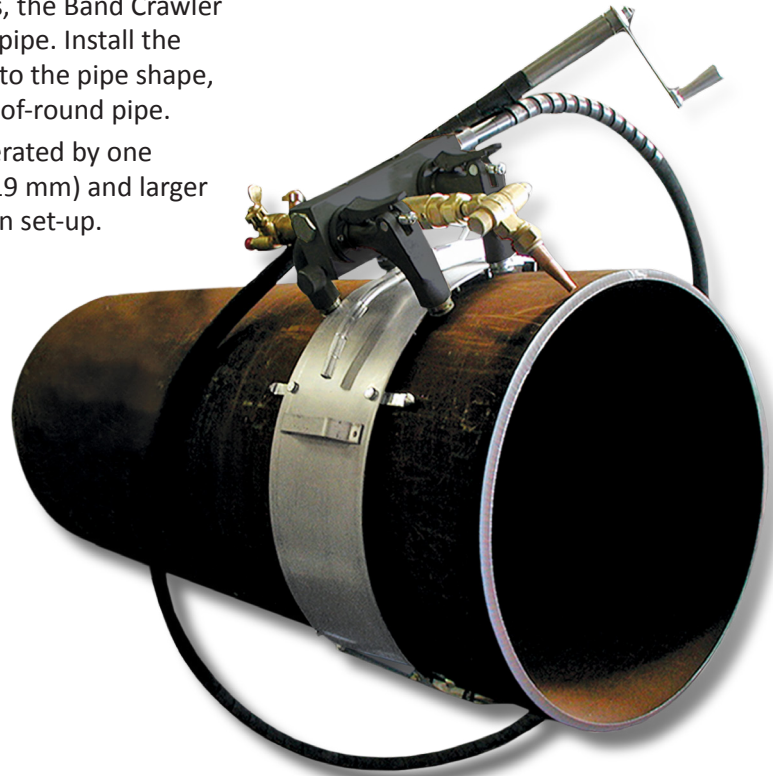

**Precise** - Band conforms precisely to the out-of-round condition of the pipe to maintain consistent cutting tip distance from pipe surface

**Simple** - One person can set up and cut horizontal or vertical pipes as large as 48" (1,219 mm)

**Low profile** - Requires as little as 10½" (267 mm) of radial clearance

**One size fits all** - One Band Crawler fits all band sizes

**Fast** - 60% faster than hand cutting and grinding

**Motorized** - Available with PLASMASPEED digital motor control

MODEL	PART NO	PACKAGED WEIGHT	
Band crawler with 9' (2.7 m) flexible drive cable	05.0116.009	26 lbs.	11.70 kg
Band crawler with 14' (4.3m) flexible drive cable	05.0116.014	30 lbs.	14.00 kg
Motorized PLASMASPEED band crawler 110/230 VAC	05.0116.S01	26 lbs.	11.70 kg
PLASMASPEED retro fit kit 110/230 VAC	05.0116.SA1	26 lbs.	11.70 kg

## TORCH ANGLE HEAD ADAPTOR

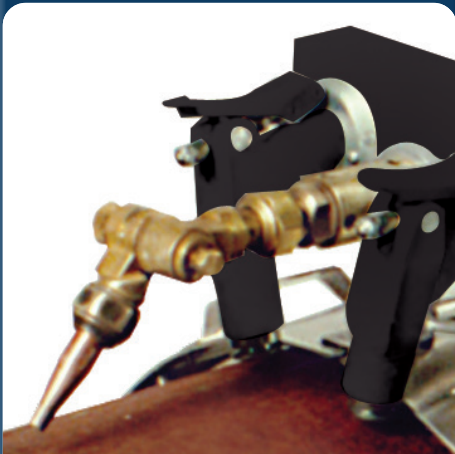

Allows the torch tip to be adjusted for any angle from a square cut (no bevel) to a bevel angle up to 90 degrees while also allowing torch lead or lag angle adjustment.

## RIGHT ANGLE DRIVE ADAPTOR



Permits the flexible drive cable to pivot 180 degrees on the end of the band crawler, lowering the profile of the crawler to 6" (168.2 mm).

## PLASMASPEED



The motorized PLASMASPEED band crawler can increase cutting and beveling efficiency of large diameter pipes up to 60% and is the quickest and easiest cutting tool to set up on vertical pipe.



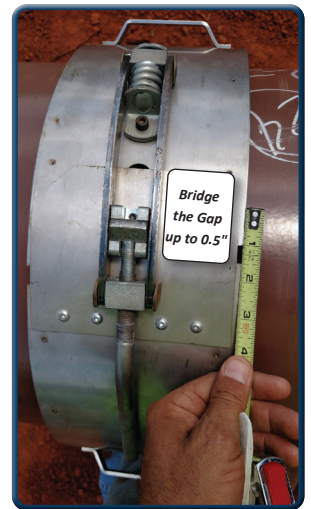
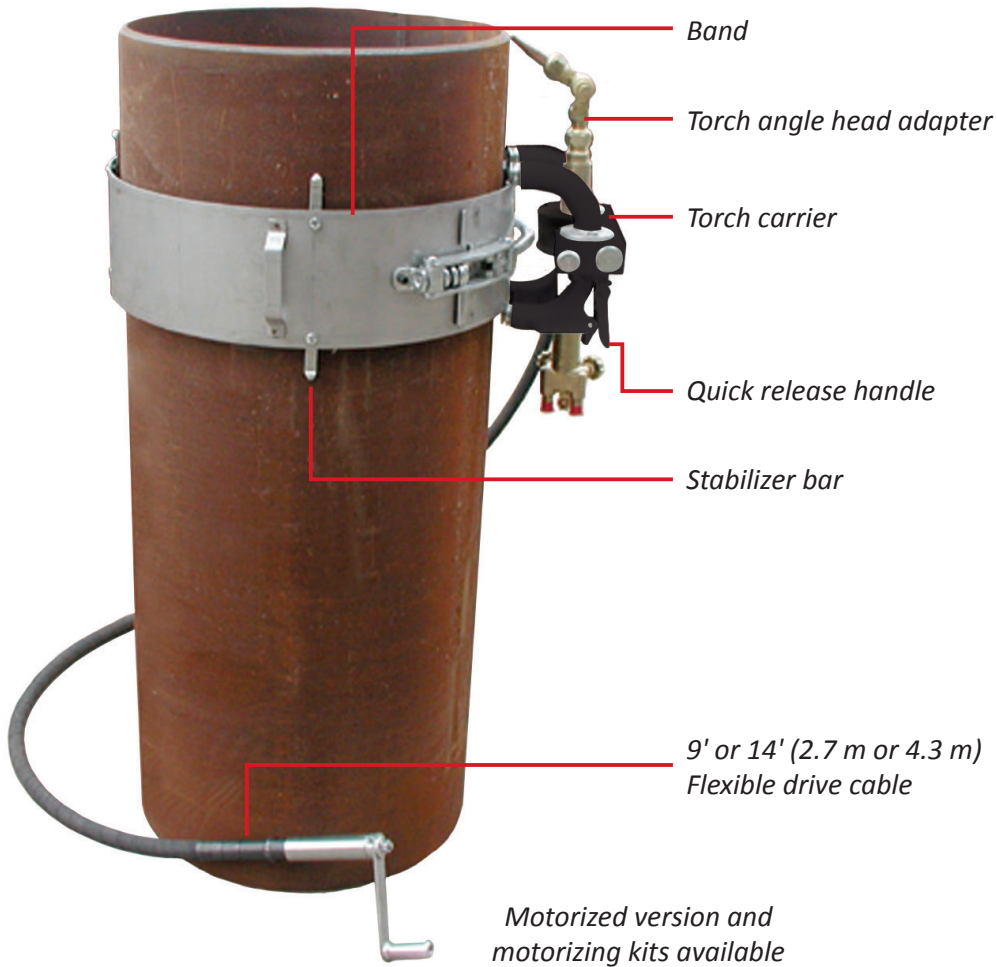

#### DRIVE CABLE

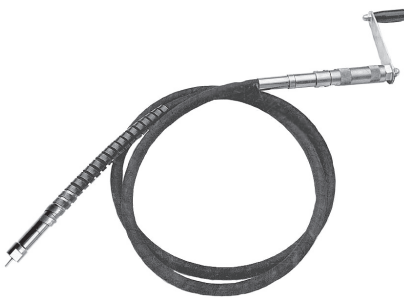

Enables the motorized band crawler to be retrofitted to manual operation.

Available in 9' (2.7 m) and 14' (4.3 m) lengths.

#### RACK ADJUSTABLE TORCH ARM

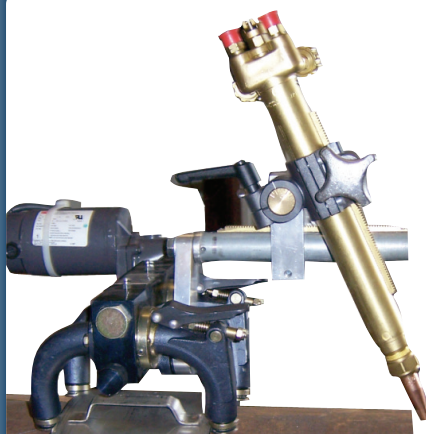

Allows both horizontal and vertical adjustment of the torch in relationship to the pipe surface.

#### DOUBLE TORCH ARM

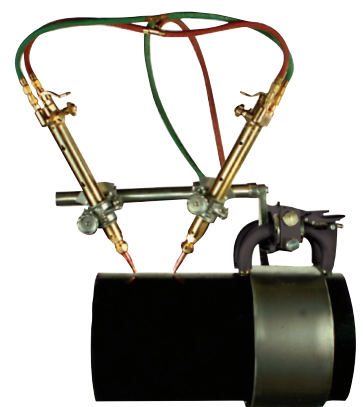

Makes two cuts and bevels simultaneously, reducing cutting time and labor.

- No more special sized bands, Better Bands Bridge the Gap - up to 3 times more gap allowance than any other bands on the market
- Patented 'staggered' latching system for improved setup
- Ensures maximum traction for the machine, maintaining 3 points of contact at all times
- Industry leading gap allowance allows one size to work on coated or out of round pipe
- Consistent speed and travel of the machine equals improved cut quality



Bridge the Gap

## Technical specification

PIPE SIZE		PART NO	PACKAGED WEIGHT	
6"	168.2 mm	05.0204.006	5 lbs.	2.00 kg
8"	219 mm	05.0204.008	6 lbs.	3.00 kg
10"	273 mm	05.0204.010	7 lbs.	3.00 kg
12"	323.8 mm	05.0204.012	7 lbs.	3.00 kg
14"	356 mm	05.0204.014	11 lbs.	5.00 kg
16"	406 mm	05.0204.016	12 lbs.	5.00 kg
18"	457 mm	05.0204.018	14 lbs.	6.00 kg
20"	508 mm	05.0204.020	16 lbs.	7.00 kg
22"	559 mm	05.0204.022	17 lbs.	8.00 kg
24"	610 mm	05.0204.024	18 lbs.	6.00 kg
26"	660 mm	05.0204.026	20 lbs.	9.00 kg
28"	711 mm	05.0204.028	22 lbs.	10.00 kg
30"	762 mm	05.0204.030	25 lbs.	11.00 kg
32"	813 mm	05.0204.032	26 lbs.	12.00 kg
34"	864 mm	05.0204.034	27 lbs.	12.00 kg
36"	914 mm	05.0204.036	29 lbs.	13.00 kg
38"	965 mm	05.0204.038	31 lbs.	14.00 kg
40"	1,016 mm	05.0204.040	33 lbs.	15.00 kg
42"	1,067 mm	05.0204.042	36 lbs.	16.00 kg
44"	1,118 mm	05.0204.044	39 lbs.	18.00 kg
46"	1,168 mm	05.0204.046	43 lbs.	20.00 kg
48"	1,219 mm	05.0204.048	90 lbs.	41.00 kg
50"	1,270 mm	05.0204.050	92 lbs.	42.00 kg
52"	1,321 mm	05.0204.052	96 lbs.	44.00 kg
54"	1,372 mm	05.0204.054	100 lbs.	45.00 kg
56"	1,422 mm	05.0204.056	106 lbs.	48.00 kg
58"	1,473 mm	05.0204.058	110 lbs.	50.00 kg
60"	1,524 mm	05.0204.060	115 lbs.	52.00 kg

## Band crawler accessories

DESCRIPTION	PART NO	PACKAGED WEIGHT	
PLASMASPEED retro fit kit 110/230 VAC	05.0116.SA1	26 lbs.	11.70 kg
Rack-adjustable torch arm	05.0116.032	3 lbs.	1.40 kg
Double torch arm	05.0116.039	4 lbs.	1.80 kg
Right angle drive adapter (for drive cable)	05.0116.030	2 lbs.	0.90 kg
Torch angle head adapter	05.0200.003	1.20 lbs.	0.50 kg
Protective leather cable sleeve	05.0550.SLV	1.50 lbs.	0.70 kg

**Guide band calculation:** Pipe diameter (inch) + 2 x 3.142 + 6 = (total inch) x 2.54 = (total cm)

E.G. 36" + 2 x 3.142 = 119.393 + 6 = (125.396 total inch) x 2.54 = (318.51 total cm)



SPECIALIZED FABRICATION EQUIPMENT GROUP

# Global Locations:



**S.F.E. GROUP HEAD OFFICE - USA**  
**SPECIALIZED FABRICATION EQUIPMENT GROUP**  
 4433 South Drive,  
 Houston,  
 Texas 77053, USA  
 Tel: +1 713 747 8502  
 E-mail: sales@sfe-brands.com

**S.F.E. GROUP HEAD OFFICE - FRANCE**  
**SPECIALIZED FABRICATION EQUIPMENT GROUP**  
 330B Route de Portes Les Valence,  
 ZI les Bosses,  
 26800 Etoile-sur-Rhône, France  
 Tel: + 33 (0) 475 575 070  
 E-mail: sales-int@sfe-brands.com

**SFE UNITED KINGDOM**  
**SPECIALIZED FABRICATION EQUIPMENT GROUP**  
 Unit 15 & 16 Grendon Industrial Estate,  
 Grendon Underwood, Aylesbury,  
 Buckinghamshire, HP18 0QX England  
 Tel: +44 (0)1869 324 144  
 E-mail: sales-uk@sfe-brands.com

**SFE GERMANY**  
**SPECIALIZED FABRICATION EQUIPMENT GROUP**  
 Ostmarkstrasse 15,  
 76437 Rastatt,  
 Germany  
 Tel: +49 (0)7222 9355100  
 E-mail: sales-germany@sfe-brands.com

**SFE KINGDOM OF SAUDI ARABIA**  
**SPECIALIZED FABRICATION EQUIPMENT GROUP**  
 Warehouse No: EM16-10, Air Base Determinant,  
 Industrial supply scheme, Ash Shulah, Dammam  
 34264, Saudi Arabia  
 Tel: + 966 50 515 8196  
 E-mail: sales-ksa@sfe-brands.com

**SFE MIDDLE EAST**  
**SPECIALIZED FABRICATION EQUIPMENT GROUP**  
 Shams Freezone  
 Sharjah  
 United Arab Emirates  
 Tel: +971 (0)50 217 1376  
 E-mail: sales-me@sfe-brands.com

**SFE INDIA**  
**SPECIALIZED FABRICATION EQUIPMENT GROUP**  
 Plot No. PAP 3, D 3 Block,  
 Chinchwad, Pune 411 019  
 Mob: +91 90 1102 4332  
 Mob: +91 95 5258 4361  
 E-mail: sales-india@sfe-brands.com

**SFE LATIN AMERICA**  
**SPECIALIZED FABRICATION EQUIPMENT GROUP**  
 4433 South Drive,  
 Houston,  
 Texas 77053, USA  
 Tel: +1 713 747 8502  
 E-mail: sales-latam@sfe-brands.com

**SFE SOUTH KOREA**  
**SPECIALIZED FABRICATION EQUIPMENT GROUP**  
 102 - 1301 Bucheon Technopark III  
 421 - 742 Gyeonggi-do-seoul, Taehan-min'guk  
 South Korea  
 Tel: +82 32 624 2870  
 E-mail: sales-asia@sfe-brands.com

**SFE VIETNAM**  
**SPECIALIZED FABRICATION EQUIPMENT GROUP**  
 P1.2.13 Sky-Linked Villa, Diamond Alnata,  
 Celadoncity, 89 Đường N1, P. Sơn Kỳ,  
 Q. Tân Phú, TpHCM.  
 Tel: +84 91 951 70 18  
 E-mail: sales-vietnam@sfe-brands.com

**SFE CHINA**  
**SPECIALIZED FABRICATION EQUIPMENT GROUP**  
 1208, 12F, #D 7001 Zhongchun RD  
 Minhang District  
 Shanghai, China  
 Tel: +86 215 429 1891  
 E-mail: sales-china@sfe-brands.com

Copyright © 2023 Specialized Fabrication Equipment Group, All rights reserved.

## OUR BRANDS

